

# Rathaus "Lindau"



"Lindau" town hall  
Mairie "Lindau"  
Raadhuis "Lindau"

Art. Nr. 232299

D

- Vor Beginn des Bastelns sollten Sie sich mit den Spritzlingen und der Anleitung vertraut machen.
- Sollte es einmal vorkommen, daß ein Teil im Bausatz fehlt, kreuzen Sie bitte das fehlende Teil in der Anleitung an und schicken Sie diese bitte an Fa. Gebr. FALLER GmbH, Abt. Kundendienst, Kreuzstraße 9, 78148 Gütenbach. Sie erhalten dann umgehend Ersatz.
- **In diesem Bausatz sind einige Kunststoffteile übrig.**

GB

- Before commencing with the assembly please familiarize yourself with the parts and read the instructions carefully.
- In case of missing parts please indicate these on the instructions leaflet with a circle and return the leaflet to Gebr. FALLER GmbH, Kreuzstraße 9, D-78148 Gütenbach, Germany. You will receive the replacement by return.
- **Some of the parts in this box are not needed to construct the model.**

F

- Avant de commencer le montage de votre maquette bien lire la notice et repérer les grappes.
- Si une pièce manquait dans une boîte, cochez la pièce correspondante sur la notice et renvoyez la nous à Gebr. FALLER GmbH, Kreuzstraße 9, D-78148 Gütenbach (R.F.A.). Nous vous ferons parvenir la pièce par retour.
- **Dans cette boîte se trouvent quelques pièces qui ne seront pas utilisées pour le montage.**

NL

- Vóór het bouwen zou men de gietstukken en de handleiding moeten bestuderen.
- Indien onverhoopt een onderdeel aan het bouwpakket ontbreekt, gelieve men het ontbrekende deel in de handleiding aan te kruisen en deze te zenden aan Gebr. FALLER GmbH, Kreuzstraße 9, D-78148 Gütenbach. U ontvangt dan omgaand en gratis het ontbrekende onderdeel.
- **Van dit bouwpakket worden enkele kunststof delen niet gebruikt.**



170492  
FALLER-EXPERT

Flüssigkleber in Plastikflasche mit Spezialkanüle für feinste Klebstoffdosierung.

FALLER-EXPERT

Liquid cement in plastic bottle with canule for very fine dosage.

FALLER-EXPERT

Colle liquide en bouteille plastique avec bec verseur pour un dosage précis.

FALLER-EXPERT

Vloeibare lijm in plastic-flacon met doseerbuisje om nauwkeurig te lijmen.



170688  
Spezial-Seitenschneider

zum gratfreien Abtrennen von feinsten Spritzteilen. Spitze 48° abgewinkelt. Nur für Polystyrol geeignet.

Special side cutter

for cutting off ultra-fine moulded parts without burrs. Tip angle 48°. Only suitable for polystyrene.

Pince coupante spéciale

pour couper sans bavure les pièces miniatures moulées par injection. Pointe coudée à 48°. Uniquement appropriée pour le polystyrène.

Speciale zijknijptang

voor het braamloos afknippen van de fijnste gietstukdelen. Hoek snijvlakken 48°. Alleen geschikt voor polystyrol.



Inhalt	Spritzlinge	1	1 x	4 A	1 x	6	1 x	9 A	2 x
Contents	Sprues	2	1 x	4 B	1 x	7	1 x	9 B	1 x
Contenu	Moulages								
Inhoud	Gietstukken	3	1 x	5	1 x	8	1 x		

Sa. Nr. 224 993 0

## 2 Fensterfolie

Schnittmusterfolie für Fenster vom Trägermaterial abziehen und auf die Fensterfolie mit gleicher Größe blasenfrei aufbringen (**ohne Klebstoff!**). Die benötigten Fenster werden ausgeschnitten und **ohne Schnittmusterfolie** auf die Rückseite der Fensterrahmen geklebt (Position laut Anleitung).

### Window foil

Pull off pattern sheet for windows from carrier and apply it, bubble-free, to the window foil of the same size (**without any glue**). Cut out the required windows and glue them to the rear side of the window frame **without pattern sheet** (position as to instructions).

### Feuille fenêtre

Rétirer la feuille matrice pour fenêtre du matériel support et l'appliquer sur la feuille-fenêtre de même dimension sans que des bulles ne se produisent (**sans colle**). Découper le nombre de fenêtres nécessaires et les coller **sans la feuille** modèle sur l'arrière des dormants (position selon instructions).

### Raam folie

Knippatroonfolie voor de ramen van schutblad afhalen en zonder blaasjes op het raam folie van dezelfde grootte aanbrengen (**niet lijmen!**). De benodigde ramen worden uitgeknipt en **zonder de knippatroonfolie** op de achterzijde van de raamkozijnen gelijmd (positie volgens handleiding).

Fensterschnittmuster 232299

Sa. Nr. 225 178 0

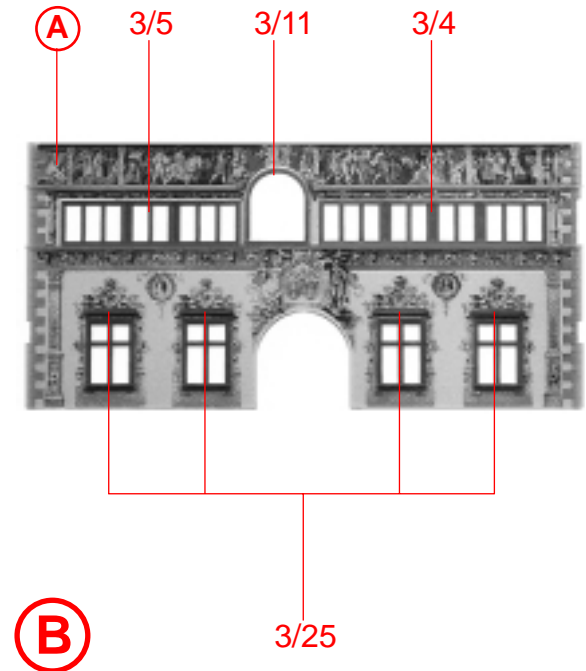
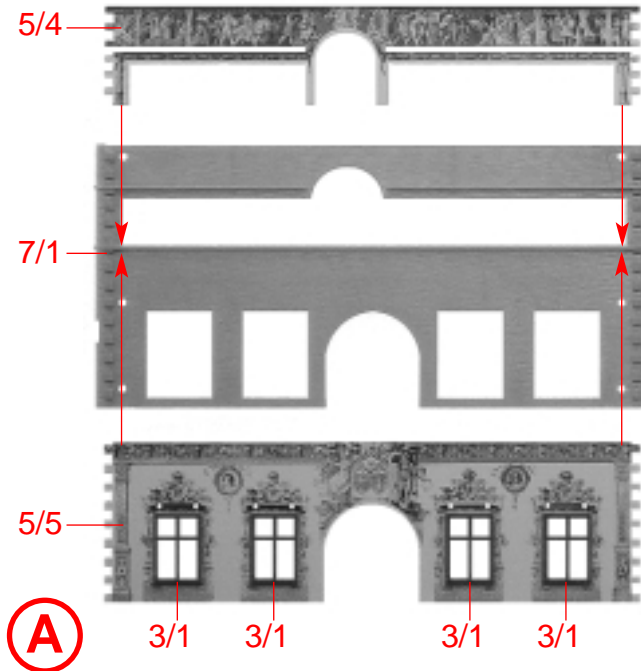
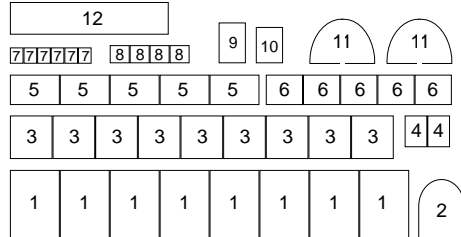

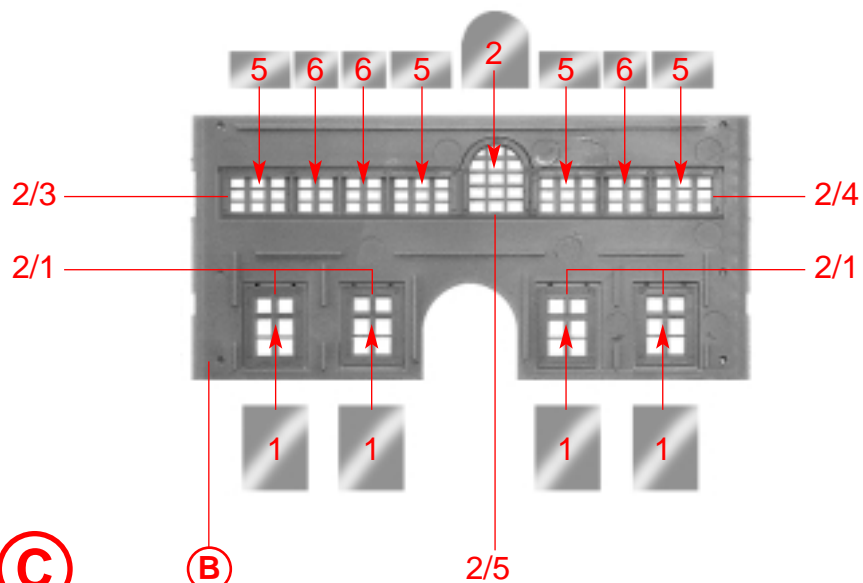

C

B

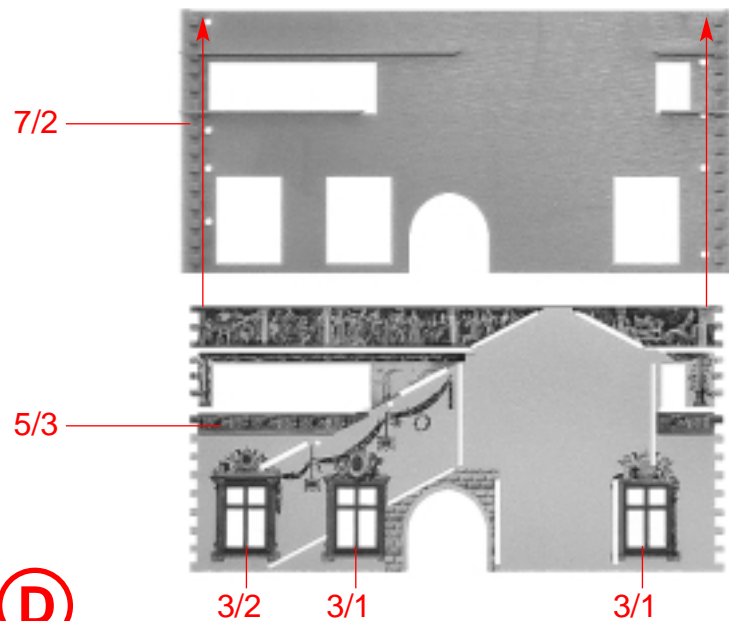

D

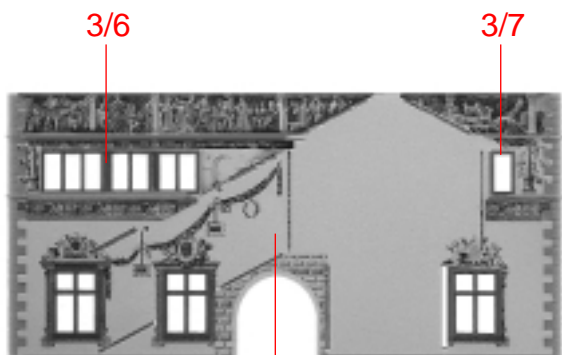

E

D

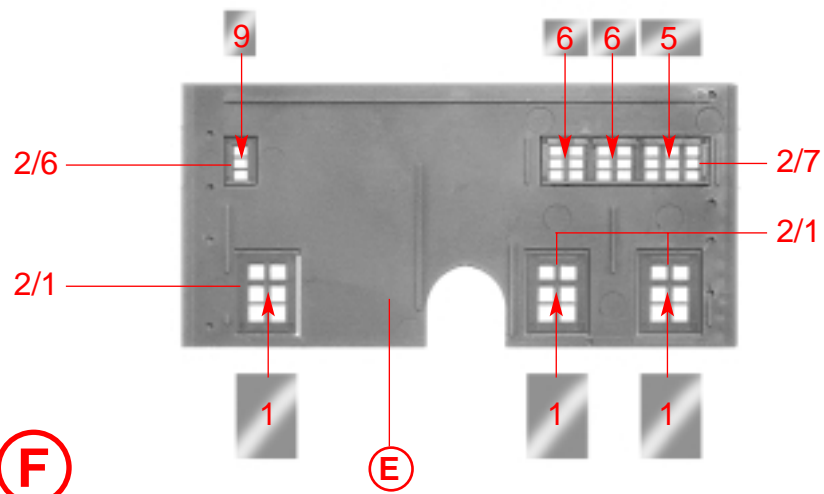

F

E

4 7/4

6/2

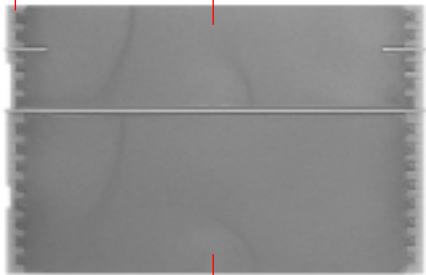

ⓐ

6/1

ⓑ

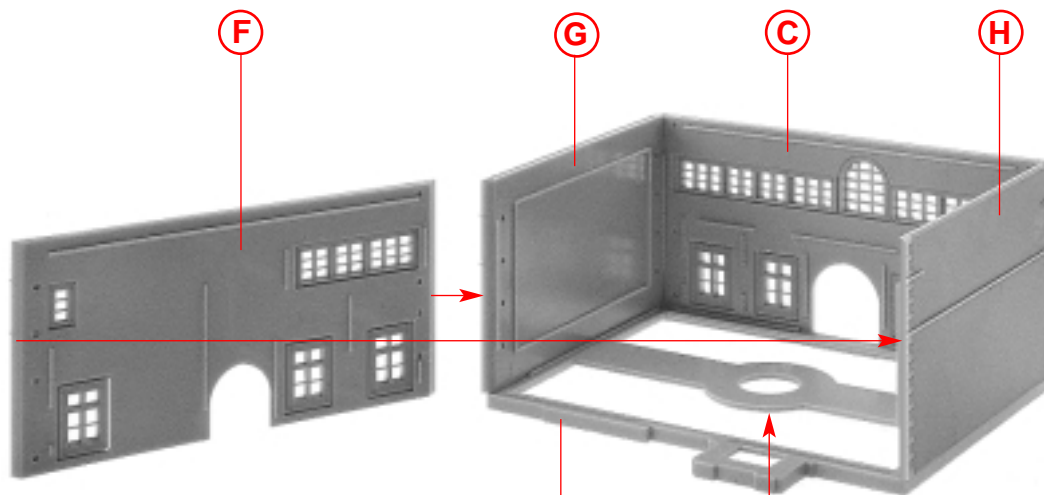

Art.-Nr.180670 liegt nicht bei  
not included  
non jointe  
niet bijgevoegd

4/1

7/3

6/2

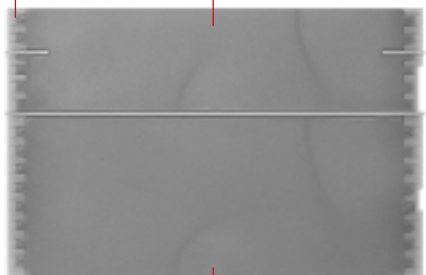

ⓓ

6/1

ⓔ

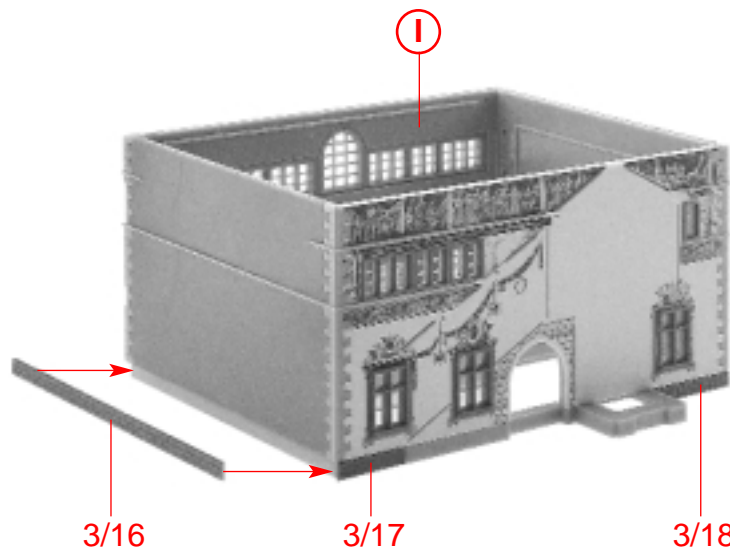

ⓑ

3/16

3/17

3/18

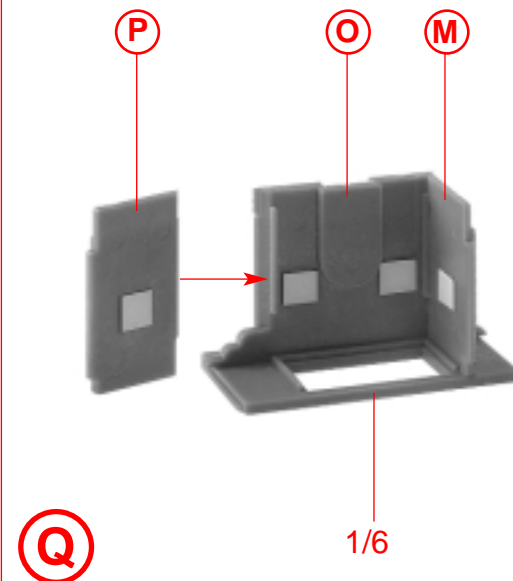
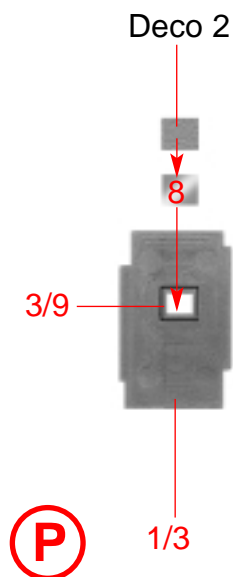
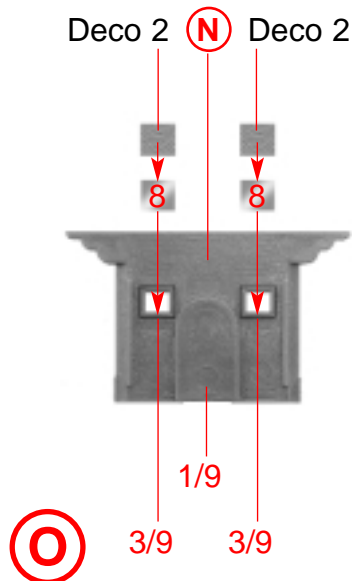
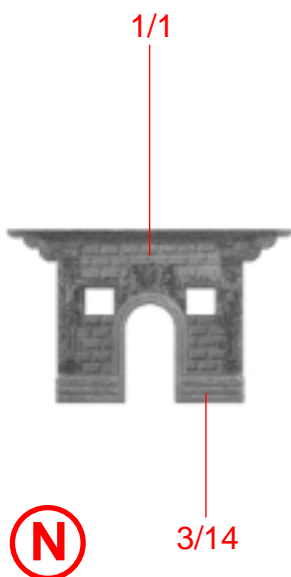
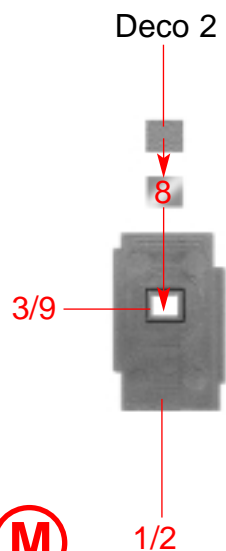
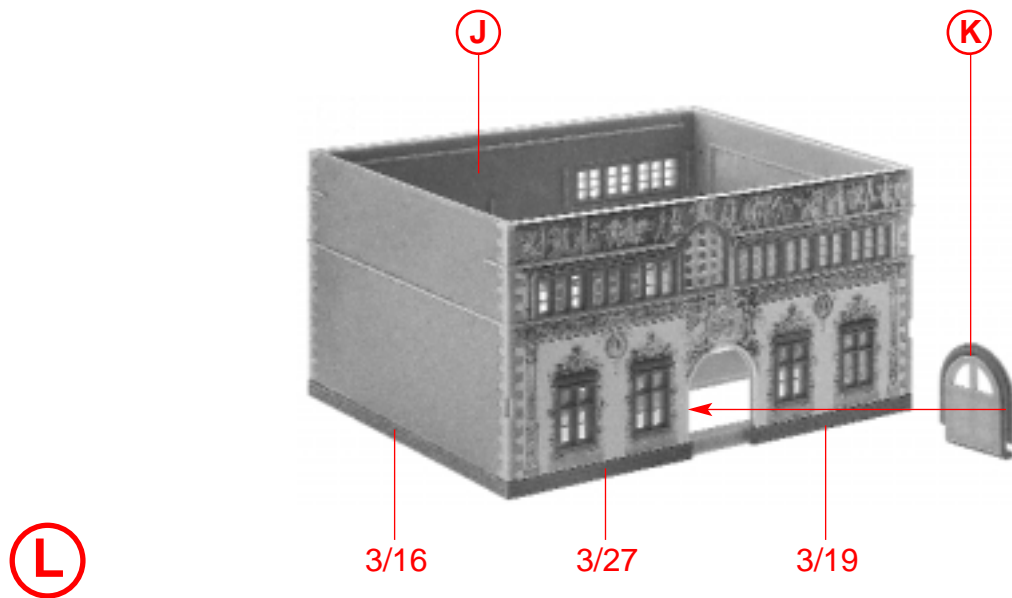
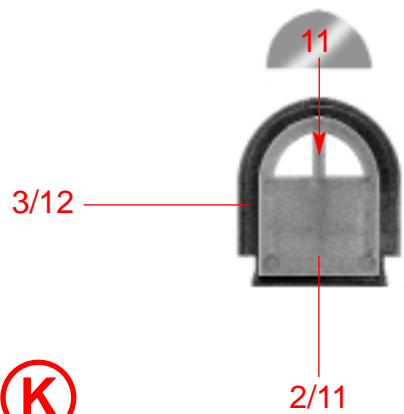

6

1/12

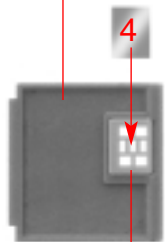

(R)

2/9

1/8

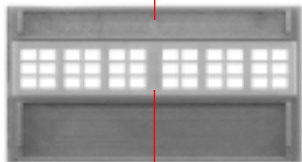

(S)

2/8

1/13

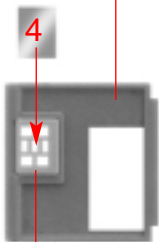

(T)

2/9

(R)

12

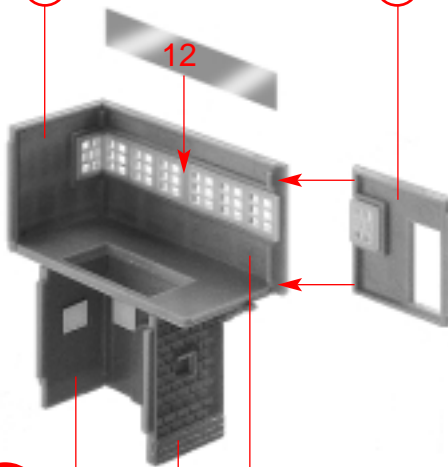

(U)

(Q)

3/15

(S)

(T)

Deco 1

1/11

1/10

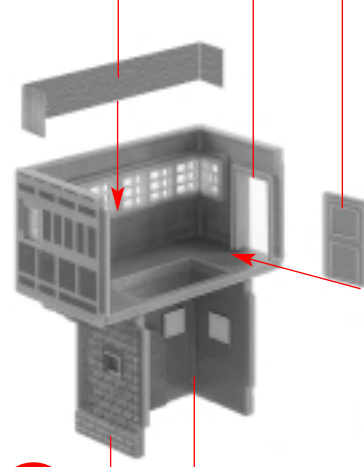

(V)

3/15

(U)

3/13

(W)

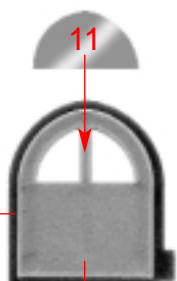

2/12

(L)

(X)

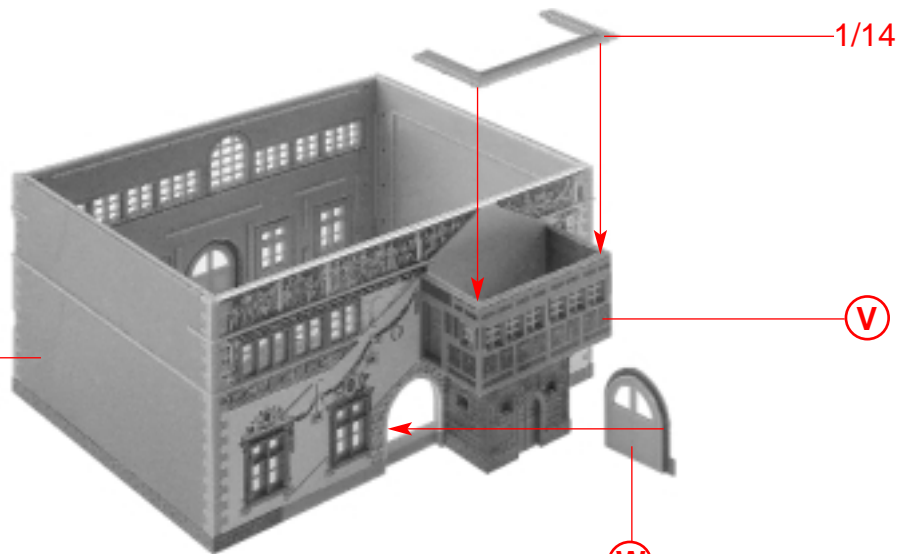

1/14

(V)

(W)

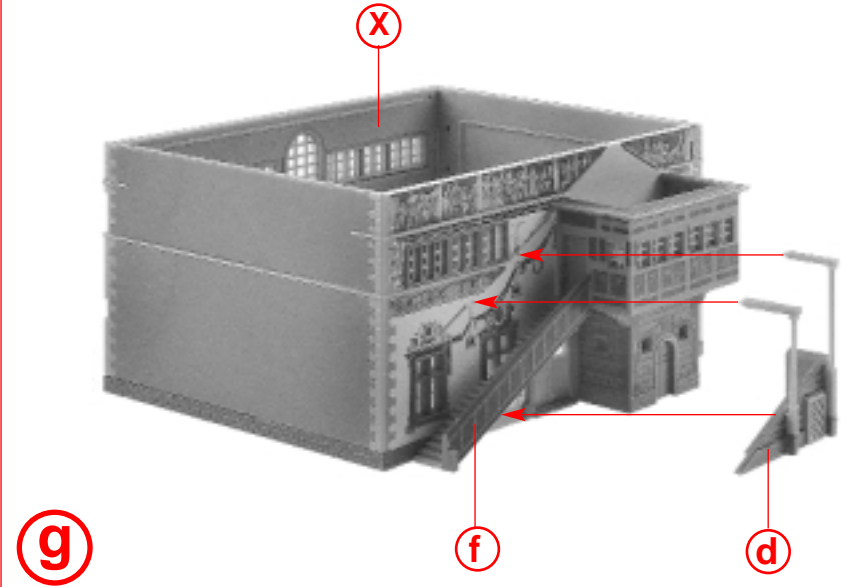
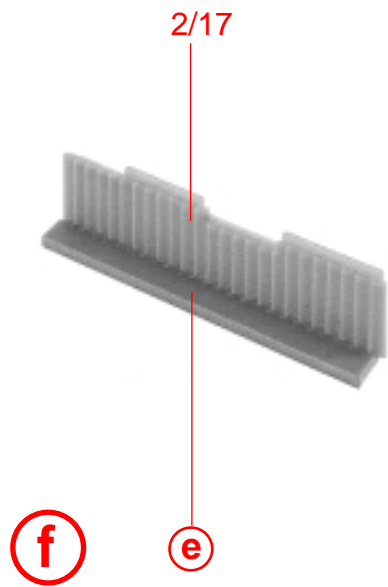
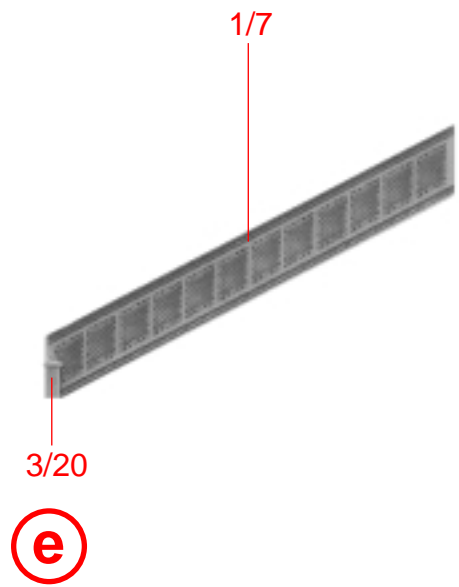
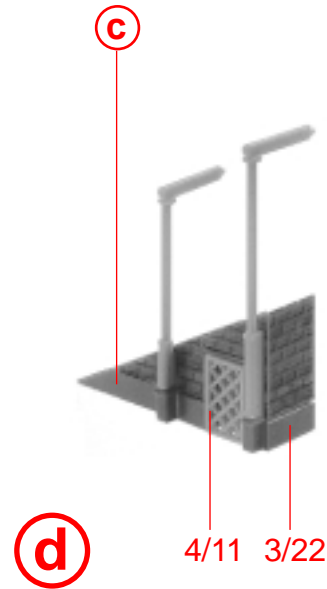
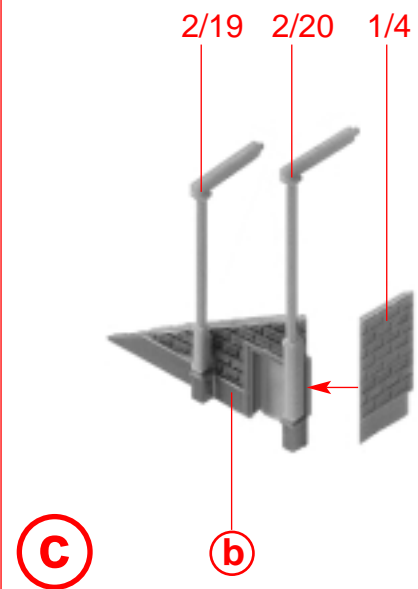
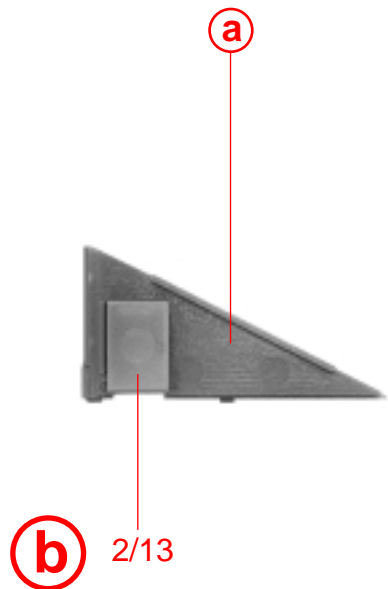
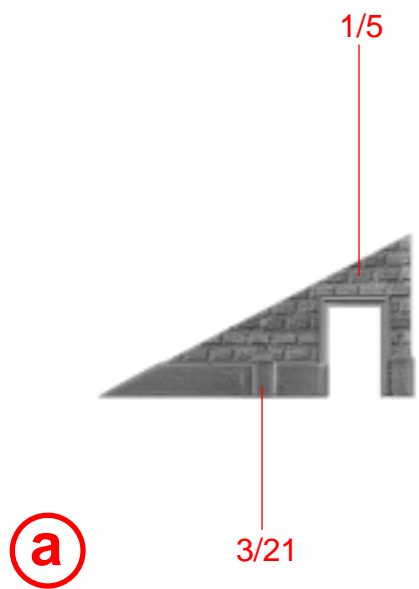

8

g

9/7

9/6

9/8

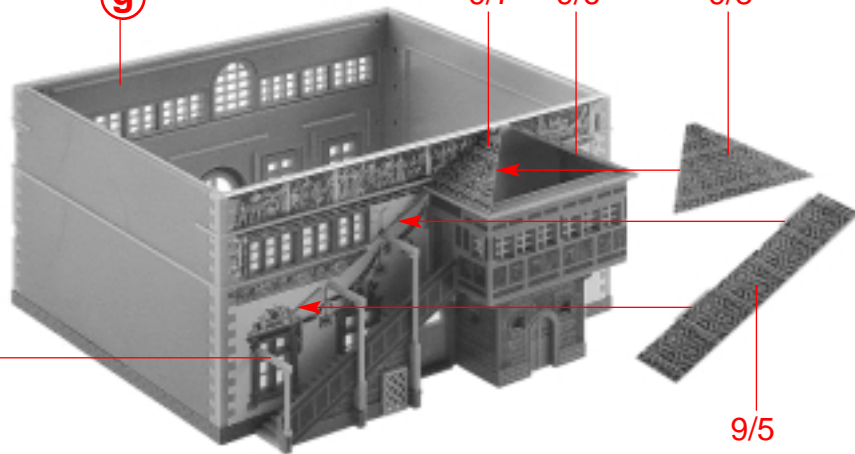

2/18

9/5

h

8/2

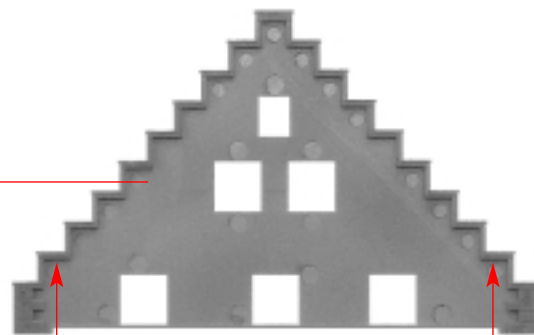

3/8

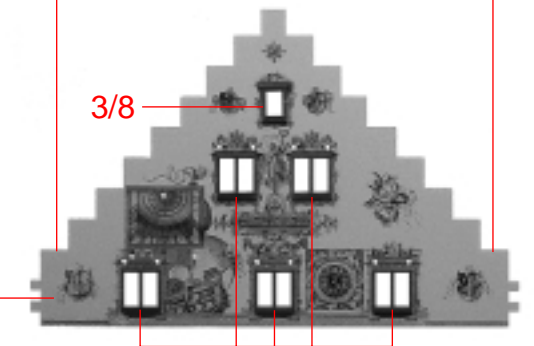

5/2

3/3

j

8/3

Papiermaske  
papermask  
masque  
masker **M1**

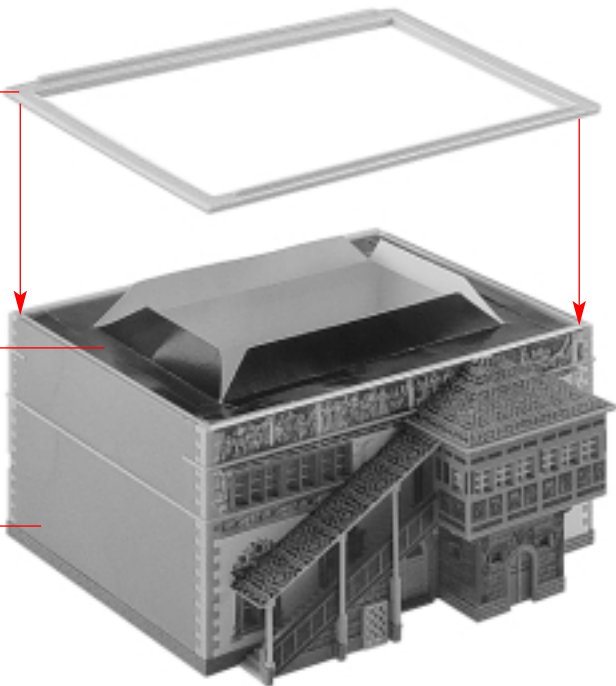

h

i

3/25

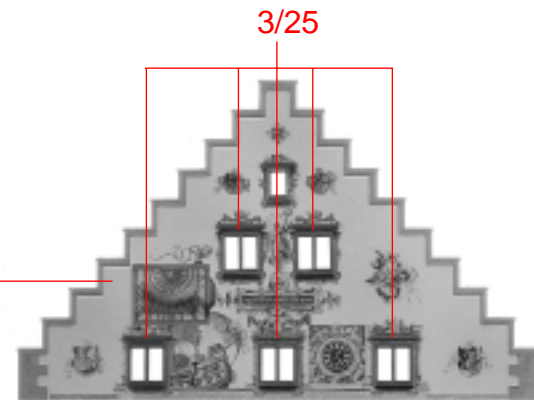

j

k



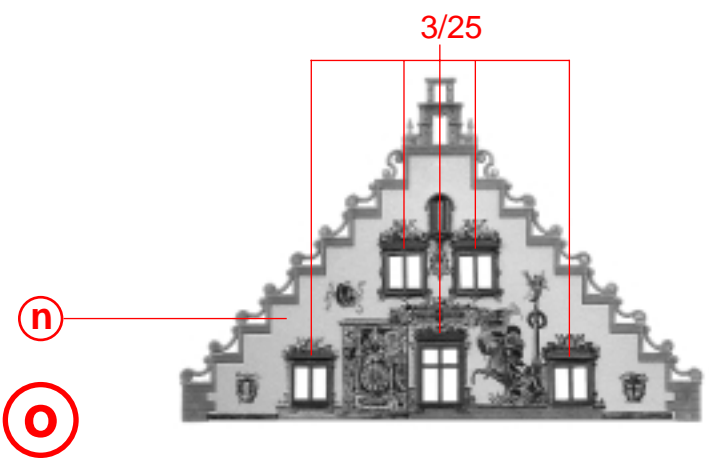
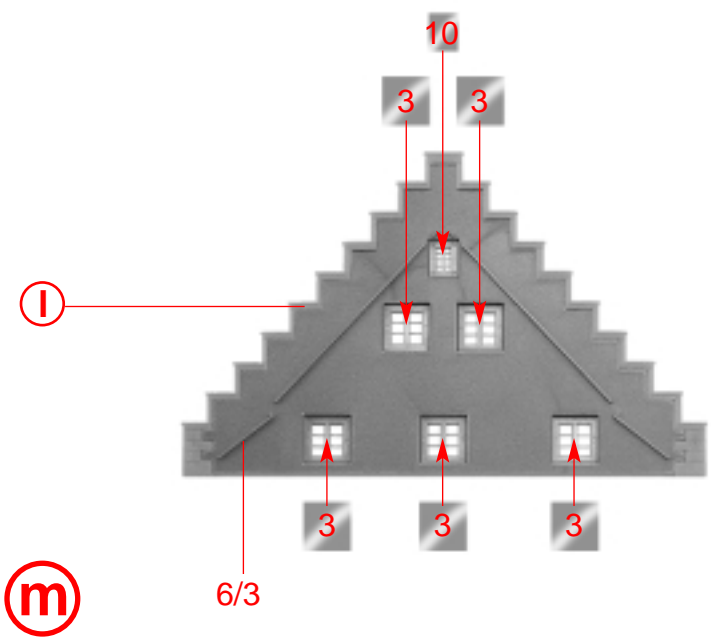
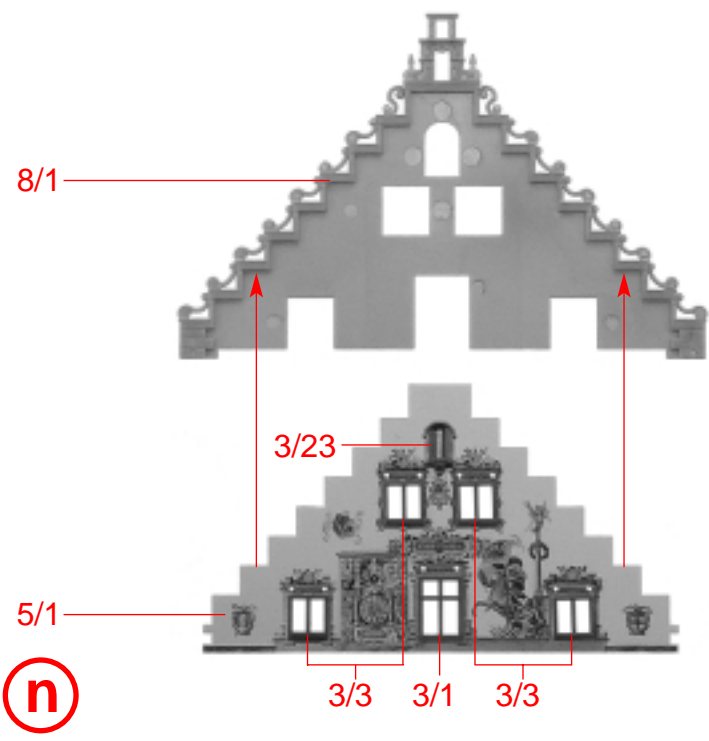
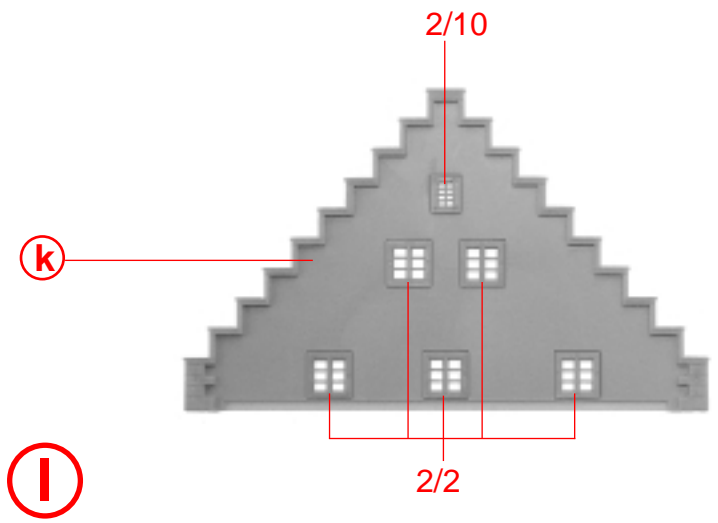

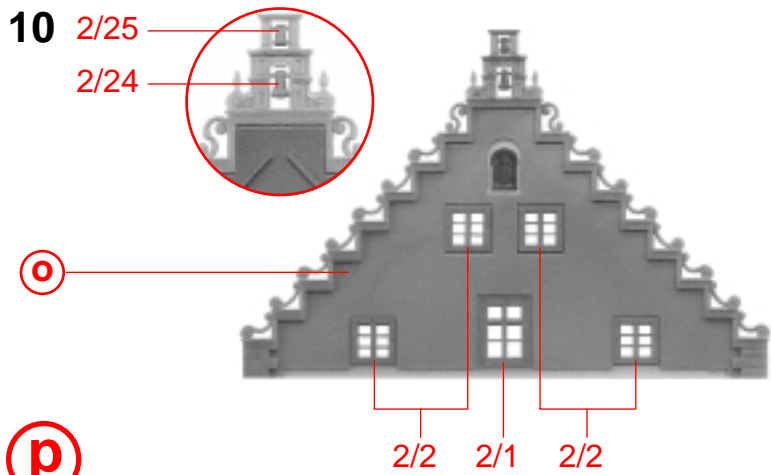

**r** 2 x

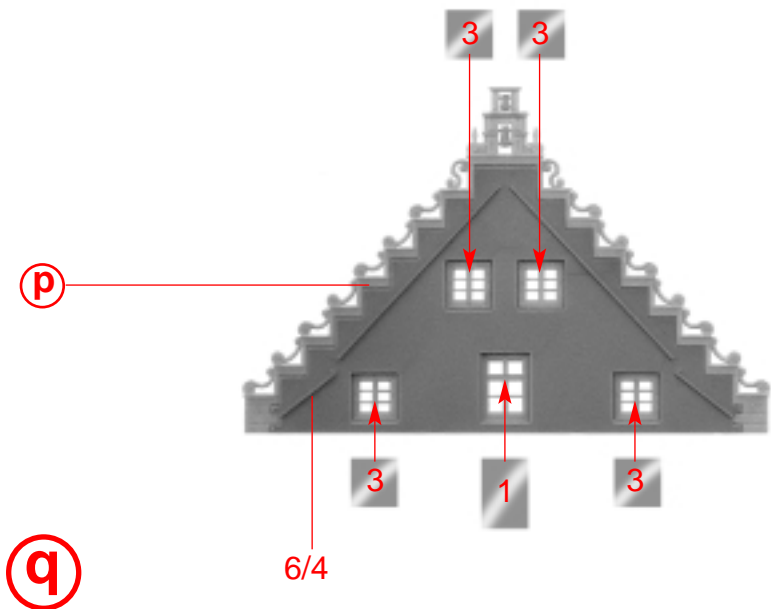
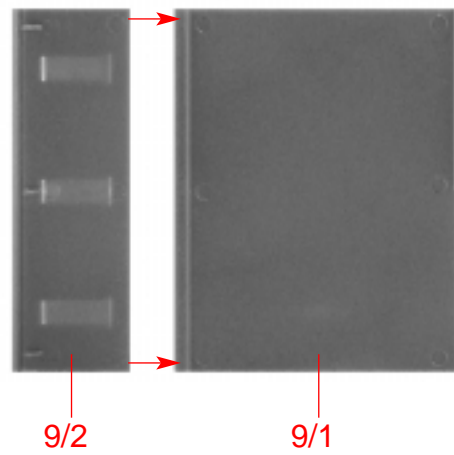

**s**

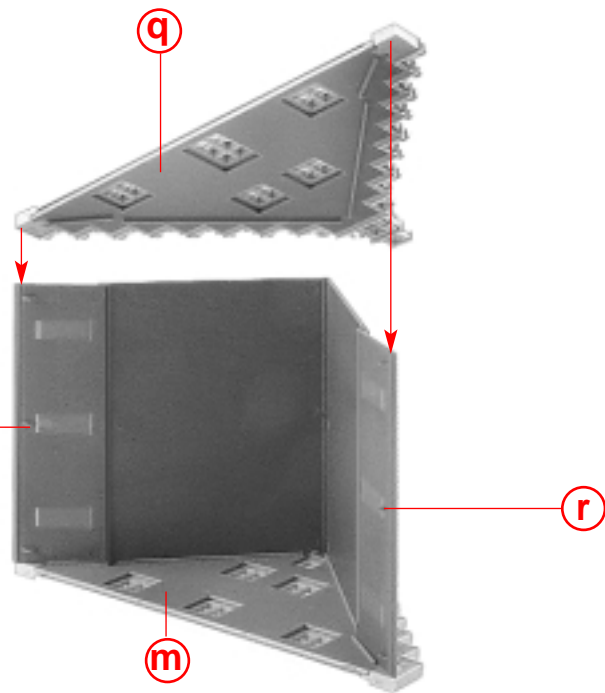

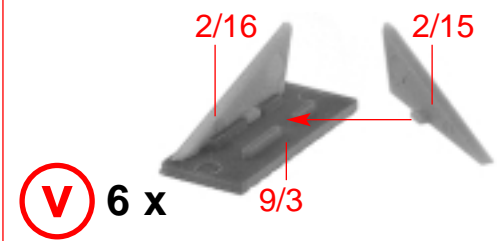
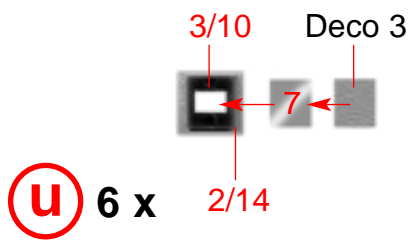
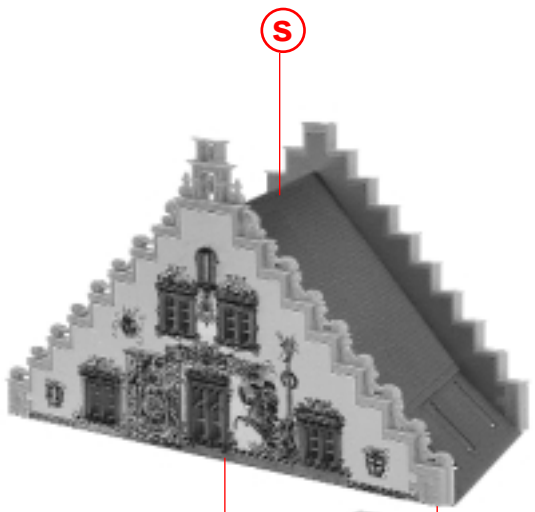

Papiermaske  
papermask  
masque  
masker **M2**

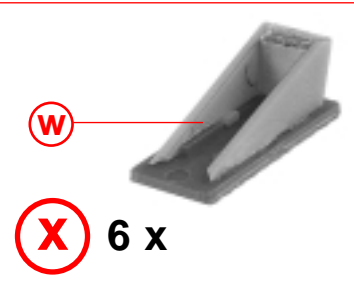
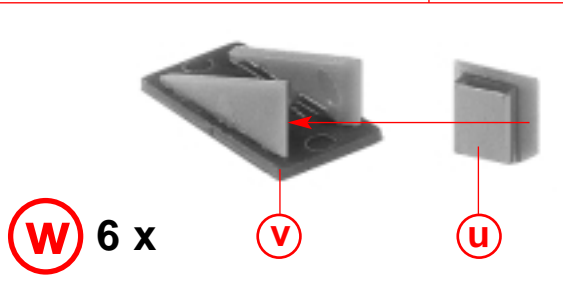
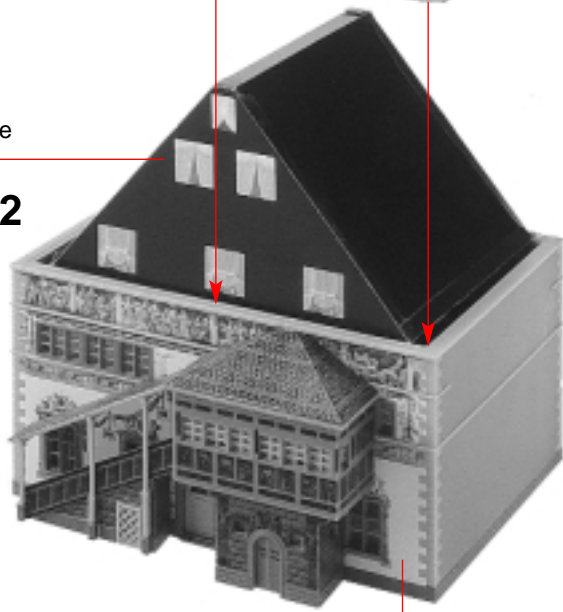

**t**

**i**

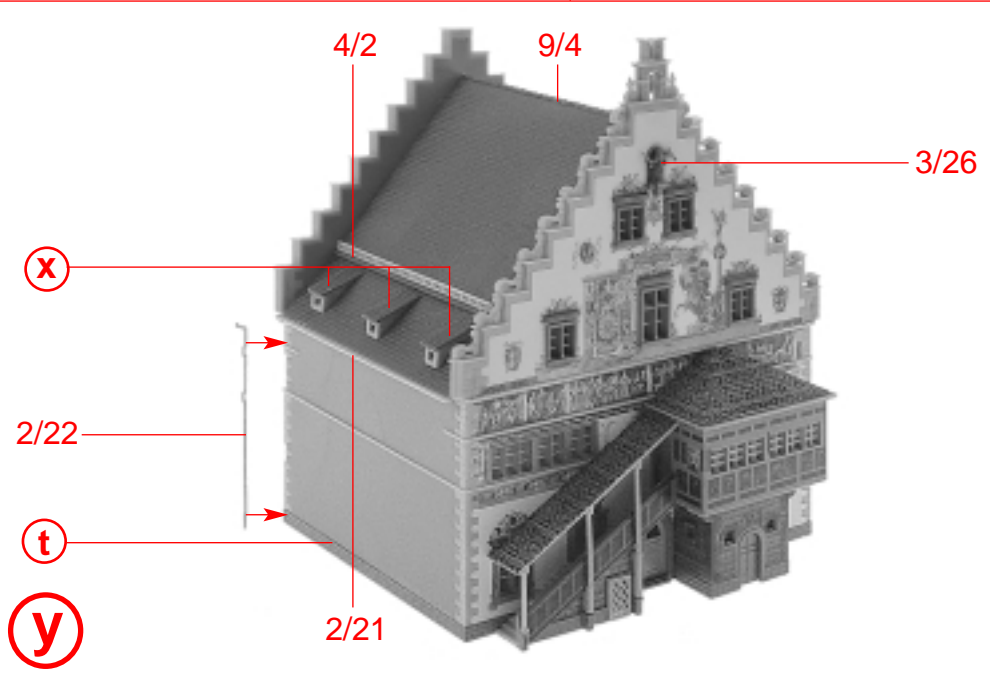

**y**

12

Deco 4

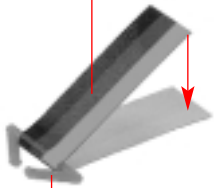

4/5

**(A)** 4 x

4/4



**(A)**

**(B)** 4 x

nicht kleben  
do not glue  
ne pas coller  
niet lijmen

4/3



**(B)**

**(C)** 4 x

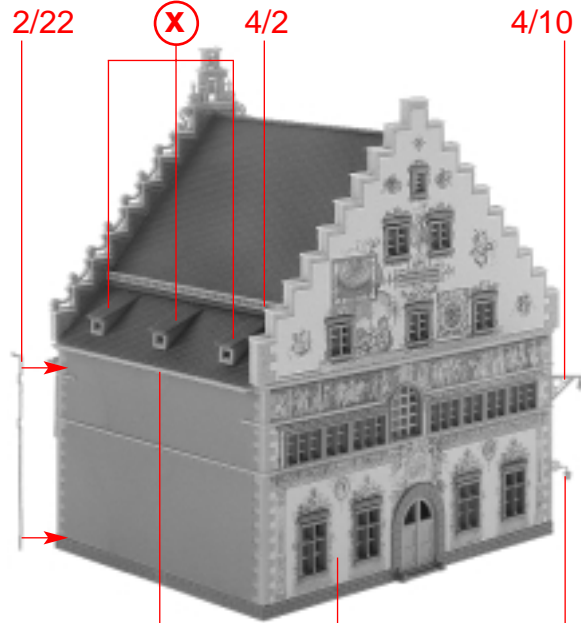

2/22

**(X)**

4/2

4/10

**(D)**

2/21

**(y)**

4/9

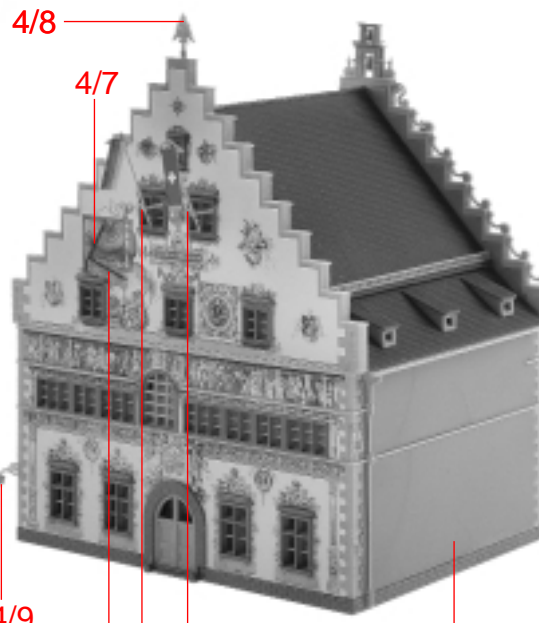

4/8

4/7

4/9

**(E)**

4/6

**(C)**

**(D)**

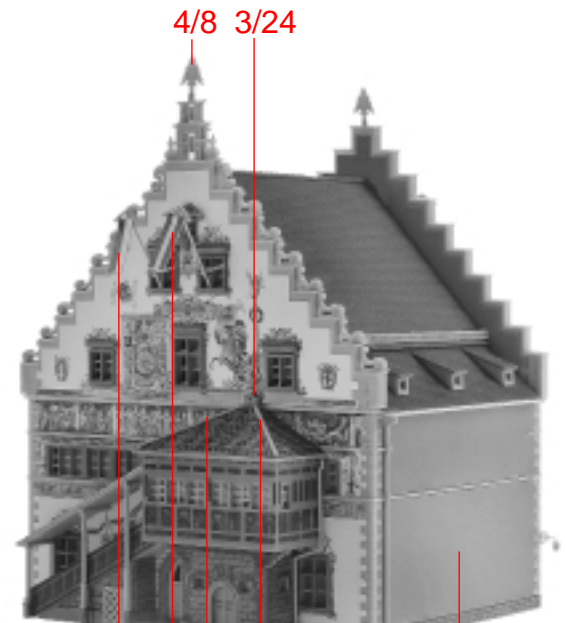

4/8

3/24

9/9

**(F)**

**(C)**

**(E)**