

# Wasserturm "Süssenbrunn"

# FALLER

## "Süssenbrunn" water tower Château d'eau "Süssenbrunn" Watertoren "Süssenbrunn"

Art. Nr. 222145

- D**
- Vor Beginn des Bastelns sollten Sie sich mit den Spritzlingen und der Anleitung vertraut machen.
  - Sollte es einmal vorkommen, daß ein Teil im Bausatz fehlt, kreuzen Sie bitte das fehlende Teil in der Anleitung an und schicken Sie diese bitte an Fa. Gebr. FALLER GmbH, Abt. Kundendienst, Kreuzstraße 9, 78148 Gütenbach. Sie erhalten dann umgehend Ersatz.

- GB**
- Before commencing with the assembly please familiarize yourself with the parts and read the instructions carefully.
  - In case of missing parts please indicate these on the instructions leaflet with a circle and return the leaflet to Gebr. FALLER GmbH, Kreuzstraße 9, D-78148 Gütenbach, Germany. You will receive the replacement by return.

- F**
- Avant de commencer le montage de votre maquette bien lire la notice et repérer les grappes.
  - Si une pièce manquait dans une boîte, cochez la pièce correspondante sur la notice et renvoyez la nous à Gebr. FALLER GmbH, Kreuzstraße 9, D-78148 Gütenbach (R.F.A.). Nous vous ferons parvenir la pièce par retour.

- NL**
- Vóór het bouwen zou men de gietstukken en de handleiding moeten bestuderen.
  - Indien onverhoopt een onderdeel aan het bouwpakket ontbreekt, gelieve men het ontbrekende deel in de handleiding aan te kruisen en deze te zenden aan Gebr. FALLER GmbH, Kreuzstraße 9, D-78148 Gütenbach. U ontvangt dan omgaand en gratis het ontbrekende onderdeel.

### 170492 FALLER-EXPERT

Flüssigkleber in Plastikflasche mit Spezialkanüle für feinste Klebstoffdosierung.

### FALLER-EXPERT

Liquid cement in plastic bottle with canule for very fine dosage.

### FALLER-EXPERT

Colle liquide en bouteille plastique avec bec verseur pour un dosage précis.

### FALLER-EXPERT

Vloeibare lijm in plastic-flacon met doseerbuisje om nauwkeurig te lijmen.



170688  
**Spezial-Seitenschneider**  
zum gratfreien Abtrennen von feinsten Spritzteilen. Spitze 48° abgewinkelt. Nur für Polystyrol geeignet.

**Special side cutter**  
for cutting off ultra-fine moulded parts without burrs. Tip angle 48°. Only suitable for polystyrene.

**Pince coupante spéciale**  
pour couper sans bavure les pièces miniatures moulées par injection. Pointe coudée à 48°. Uniquement appropriée pour le polystyrène.

**Speciale zijknijptang**  
voor het braamloos afknippen van de fijnste gietstukdelen. Hoek snijvlakken 48°. Alleen geschikt voor polystyrol.



<b>Inhalt</b>	Spritzlinge	1	1 x	4	1 x
<b>Contents</b>	Sprues	2	1 x	5	1 x
<b>Contenu</b>	Moulages	3	1 x	6	1 x
<b>Inhoud</b>	Gietstukken	3	1 x	6	1 x

Sa. Nr. 183 017 0

2

1

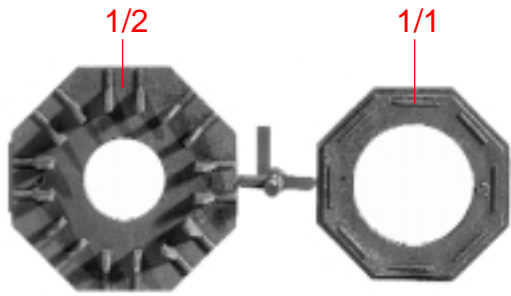

4

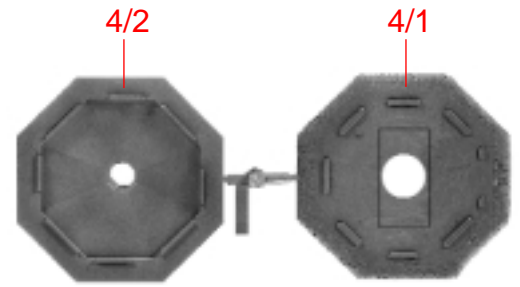

2/6

2/5

2

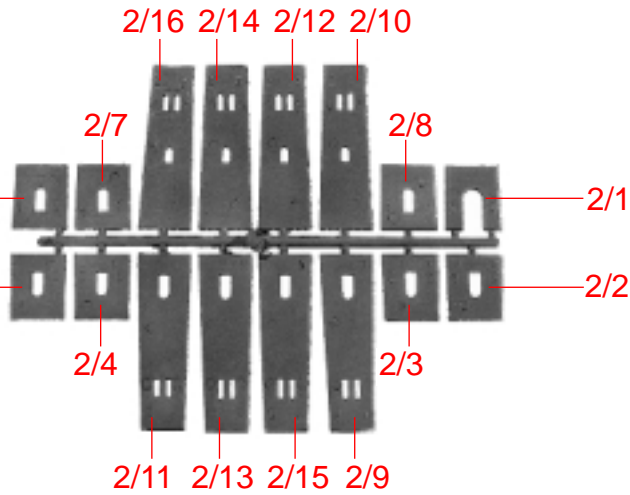

5

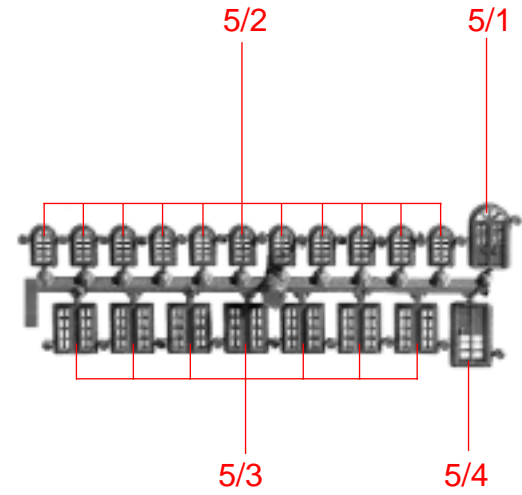

3/4

3

3/5

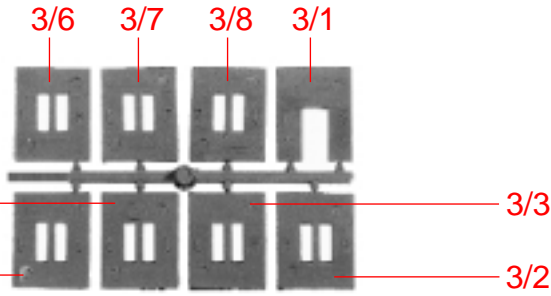

6

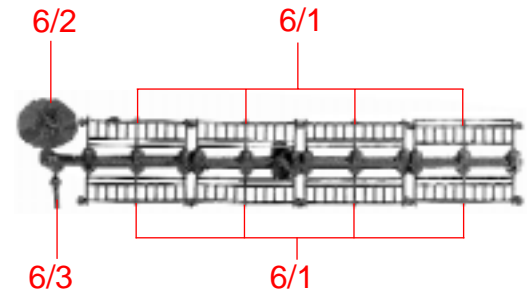

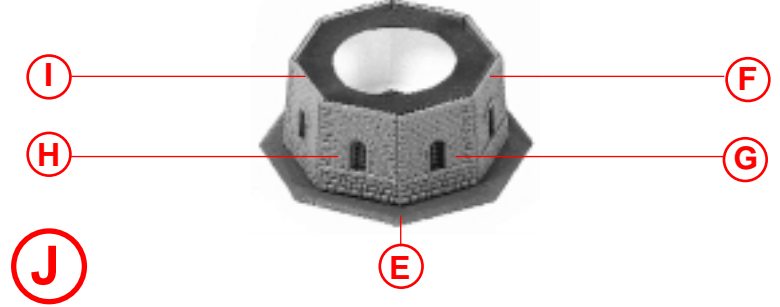
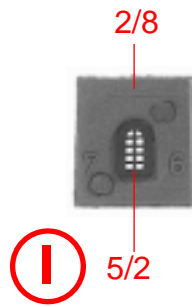
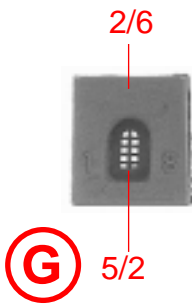
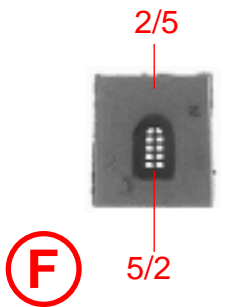
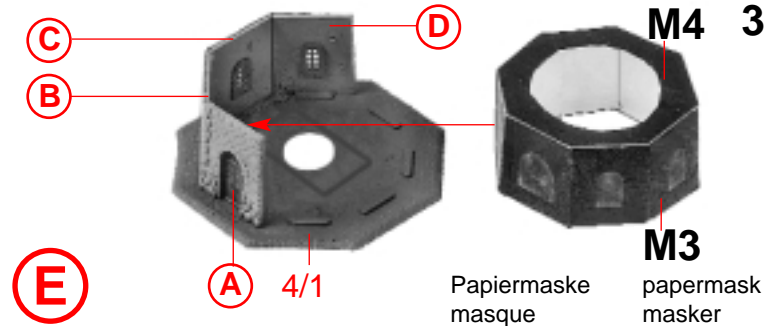
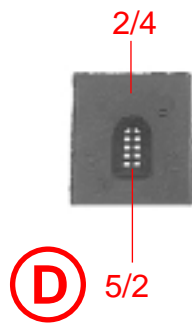
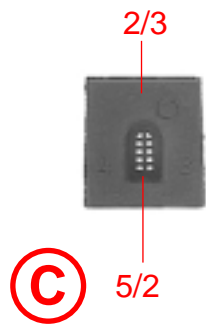
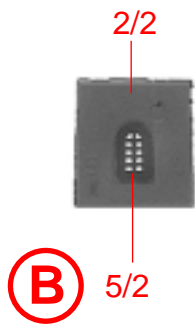
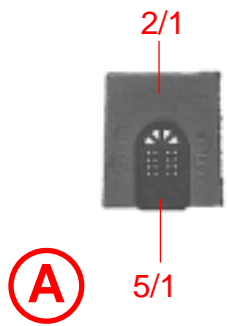

4

